

Owner's Manual
Competition™ 15-55x52
Precision Benchrest 8-32x56
Precision Benchrest 12-42x56

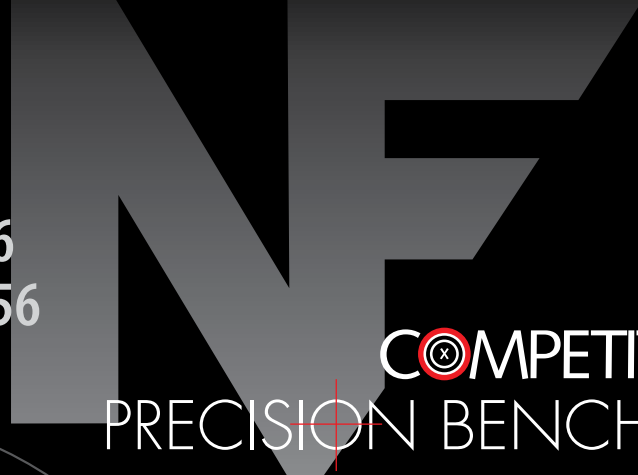

COMPETITION™
PRECISION BENCHREST



NIGHTFORCE®

Contents

| | |
|--|----|
| Nomenclature and features | 3 |
| Focusing the reticle | 4 |
| Parallax adjustment | 5 |
| Elevation and windage values | 6 |
| Reticle illumination (Precision Benchrest only)..... | 6 |
| Installing the riflescope | 7 |
| Leveling the reticle..... | 9 |
| Establishing a sight-in zero..... | 10 |
| Zeroing adjustments (Precision Benchrest) | 10 |
| ZeroStop™ elevation adjustments (Competition™) | 11 |
| Caring for your riflescope..... | 13 |
| Nightforce accessories | 14 |
| Warranty and service..... | 15 |
| Warranty registration..... | 17 |
| Owner's comments..... | 18 |

Record the riflescope serial number below for future reference:

WARNING!



Make sure that your rifle is not loaded before proceeding. Reconfirm that the chamber is empty if you stop the procedure then resume later.

WARNING!



Nightforce Optics, Inc. does not authorize the export of these items outside of the United States of America. Riflescopes and accessories listed within, are controlled for export by the U.S. Department of State, under the International Traffic In Arms (ITAR) regulations (22 CFR, Parts 120-130), and/or the Department of Commerce under the Bureau of Industry and Security Export Administration Regulations (15 CFR, Parts 730-774). To export these products outside of the United States of America, you must comply with the regulatory agency's license and documentation requirements.

Precision Benchrest:
8-32x56
12-42x56

Competition™:
15-55x52

- | | |
|---|--|
| A: Objective/Objective Lens | E: Elevation Adjustment |
| B: Eyepiece | F: Windage Adjustment |
| C: Illumination Control | G: Power Zoom Ring |
| D: Side Parallax Adjustment (Competition™ models only) | H: Adjustable Objective (Benchrest models only) |
| I: Fast-Focus Ring | |

Product specifications, features, appearances and information subject to change without notice. For the latest updates and information regarding our products, visit www.NightforceOptics.com.

COMPETITION™ PRECISION BENCHREST Nomenclature and features

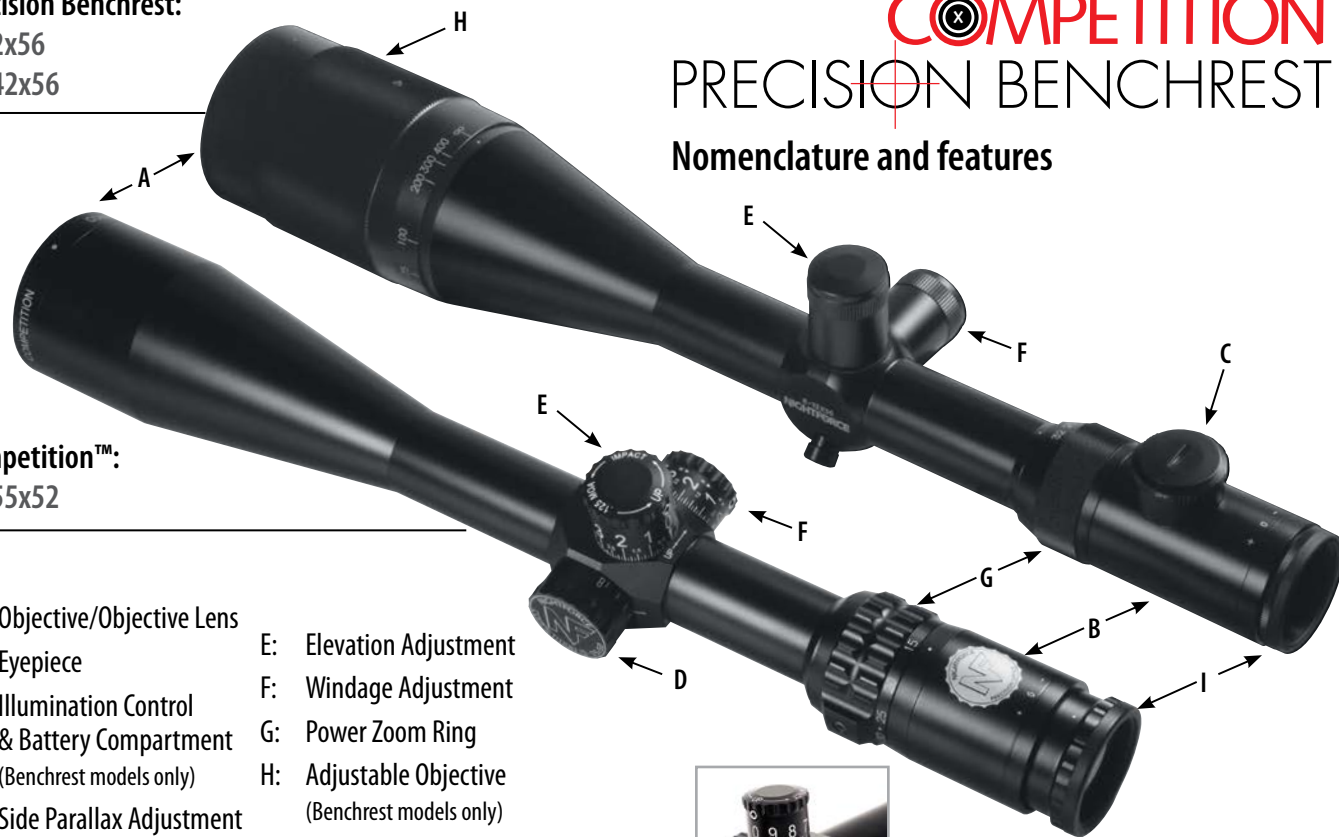

Competition™ high-visibility windage and elevation adjustments



WARNING!

To avoid permanent eye damage or blindness, do not look directly at the sun or other extremely bright lights through the riflescope.

Focusing the Reticle

There are two user-adjustable optical settings on Nightforce Competition™ and Precision Benchrest riflescopes: the reticle focus and the parallax adjustment. The reticle focus is used for setting the reticle focus to match your particular vision. It should not be used to try to focus for parallax. If you plan to wear vision correction when shooting, then set this focus while wearing your corrective lenses. **The reticle focus should be set before setting the parallax adjustment.** If the reticle focus is inadvertently set to the extreme ends of travel it can adversely effect parallax. Record the number of turns you have made on the eyepiece from the original factory setting so you can return to it if needed.

Note: All Nightforce riflescopes are factory set for average eye strength, so this adjustment may not be necessary.

1. Set the power zoom ring at the highest magnification.
2. On riflescopes with parallax adjustment, set it to the infinity setting [∞].

3. Look through the riflescope eyepiece at a light colored background such as a white wall, overcast sky, or drape a thin white cloth over the objective to eliminate background clutter. Determine if the reticle is clear and in focus instantly when you look through the eyepiece. Be aware that staring at the reticle for more than two seconds during this process will cause your eye to compensate, resulting in a false indication of reticle focus. Look away for a few seconds then retry for best results. You are looking for a sharp, crisp and well defined reticle image.

4. If adjustment is necessary, follow the steps outlined for the type of Nightforce riflescope you have. Due to the way the human eye focuses, best results are usually obtained by turning the eyepiece inward until the reticle is slightly blurred then moving it outward until sharp focus is obtained. Refer to Figure 1.

Reticle Focus Adjustment

Nightforce Competition™ and Precision Benchrest models have a fast focus eyepiece without any locking mechanism. Turn the knurled ring on the end of the eyepiece inward until the reticle is out of focus, then turn it outward until the sharpest reticle image is achieved. The friction-fit design maintains the focus once set.



Figure 1: Reticle Focus

If the reticle tends to fade in and out of focus, or you are experiencing eye strain with extended shooting sessions, that is an indicator that the reticle is not properly focused for your eye.

Once you have achieved the best focus you can, using the method above, it is recommended that you fine-tune the focus one to two turns in either direction, on a target at 100 to 200 yards. Use a target of medium value such as light tan or gray, rather than white, for best results. A properly focused reticle will remain sharp for extended periods.

Parallax Adjustment

Nightforce Competition™ and Precision Benchrest riflescopes have parallax adjustment mechanisms. Parallax is the apparent movement of the reticle in relation to the target as the shooter moves his eye across the exit pupil of the riflescope, caused by the target and the reticle being on different focal planes. A nod of the head up and down will quickly determine if parallax is present. If parallax has been eliminated, the reticle will remain stationary in relation to the target regardless of eye placement.

Note: The greater the distance, the greater the parallax error becomes. Especially at longer distances, significant sighting error can result if parallax is not removed.

Competition™ models have a side parallax adjustment found on the left side of the riflescope, directly opposite the windage adjustment. Precision Benchrest models have an adjustable objective parallax focus ring, found on the front of the riflescope. See Figure 2.

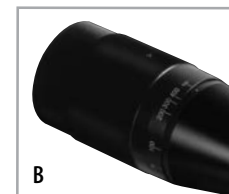
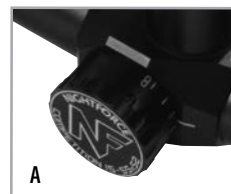

Figure 2

A) Competition™ side parallax adjustment
B) Precision Benchrest adjustable objective

Elevation and Windage Values

When making elevation (see Figure 3) and windage adjustments, you need to know how much the impact will move with each click. Scope adjustments are an angular system of measurement and do not move in a linear value. (e.g., 1 MOA is 1.047" at 100 yards, 2.094" at 200 yards, 3.141" at 300 yards, etc.) Your riflescope is going to have click values as follows:

- Competition™ and Precision Benchrest riflescopes are calibrated in 1/8 (0.125) MOA increments. They provide true MOA measurements, where a MOA is 1.047" at 100 yards.



Precision Benchrest
Competition™
Figure 3

Reticle Illumination (Precision Benchrest only)

Nightforce Precision Benchrest riflescopes are equipped with illuminated reticles. The illumination can be used to make the reticle more visible in low light situations or against darker targets. The intensity of the illumination is easily adjustable in the field. See Figure 4. **Competition™ reticles are not illuminated.**

Using reticle illumination

The illumination adjustment is found on the eyepiece for Precision Benchrest models. Turn the adjustment to the desired intensity setting or to the off position when no illumination is desired.

To replace the battery, unscrew the top of the adjustment counterclockwise, with a coin inserted in the slot provided. See Figure 5.

Depending on the intensity and conditions, your battery can last up to 720+ hours of continuous use. Replace depleted batteries with an Energizer® CR2032 or equivalent. Install the battery with the positive (+) side up. Don't forget to turn off the illumination when not in use to prevent depletion of the battery.



Figure 4: Illumination control
Precision Benchrest only



Figure 5: Battery replacement
Precision Benchrest only



WARNING!

Make sure that your rifle is unloaded prior to installing any Nightforce riflescope or accessory. Recheck the chamber if you stop the procedure and resume later.

Installing the Riflescope

FAILURE TO PROPERLY INSTALL THE RIFLESCOPE MAY CAUSE EQUIPMENT AND/OR PERSONAL DAMAGE WHICH CAN RESULT IN EQUIPMENT FAILURE OR DEATH RESPECTIVELY.

Note: Please take time to record your serial number on the inside front cover of this booklet. It can then be easily referenced for your online Warranty Registration. Once the scope has been installed, you may not be able to read the serial number, as your rings/mounts may cover it.

Nightforce Torque Specifications

- Base and Direct Mount™ attachment screws - 25 inch pounds
- Ring top screws - 25 inch pounds
- Ring crossbolt nut - 68 inch pounds
- Ring crossbolt nut for six-screw 34mm rings - 100 inch pounds

- Unimount™, Extended Unimount™ and MagMount™ crossbolt nut - 68 inch pounds
- Refer to recommended specifications on Nightforce accessory packaging

Ring and Base Selection

Your riflescope and rifle are only as good as the link between them. The mounting of your riflescope is as important as the bedding of the rifle's action to the stock. To ensure the highest level of performance, the following steps in the mounting procedure must be followed as described.

We recommend Nightforce bases, rings and one-piece mounts for a solid and precise installation. Please use the following guidelines to select the proper mounting solutions for your rifle.

- A high quality ring and base combination using a 1913 Mil. Std. type rail is recommended for field use and/or high-recoil applications. Nightforce rings, bases, Unimount™, MagMount™ and Direct Mount™ are ideal for virtually all applications.
- Under no circumstances do we recommend the use of turn-in style rotary/dovetail type ring and base designs, especially those equipped with windage adjustment.
- If we do not offer a ring/base combination that is compatible with your firearm, please consider using Talley Mfg. or Warne products.

Mount Installation

Note: Do NOT lap the Nightforce Unimount™, Extended Unimount™, Direct Mount™, MagMount™ or Ultralite™ rings. Lapping is not necessary with these Nightforce accessories. Lapping these products will void the Nightforce accessory warranty and may lead to slipping and/or crushing of the Nightforce riflescope main tube. Other manufacturer's ring/base combinations may or may not require lapping.

Attaching the Base to the Action

Once you have determined that the base-to-action mating is acceptable, install the base to the action, torquing the mounting screws to the manufacturer's specifications.

Attaching Rings to Base

Clean/degrease the inside of the rings and then clean the outside of the scope tube before installing in the rings.

Install the rings on the base per the manufacturer's specifications using the proper torque on the locking mechanism. Avoid positioning the rings where they will make contact with the adjustment assembly, the objective bell section, or the power zoom ring on the riflescope body. Apply forward pressure to the ring while tightening it in place to keep the cross bolt on the ring in firm contact with the forward surface of the cross slot in the base.

With Nightforce rings and one-piece bases you should not lap the rings.

 **WARNING!**

With hard-recoiling rifles, serious injury or even death can result from eyepiece impact with the shooter during the recoil process when discharging the firearm. Be certain that your installation provides sufficient eye relief for the recoil generated by your rifle before shooting the firearm. NOTE: Give special attention to this warning when shooting uphill and/or from a prone position. These shooting conditions can dramatically reduce eye relief. PLEASE maintain maximum eye relief when shooting heavy recoiling and/or magnum firearms.

With other brands lapping may be required. If the scope lays into the rings stress-free, there is no need to lap the rings. If required, we recommend lapping be done by a qualified technician or gunsmith. Do not overlap the rings. Damage to the scope from improper lapping/installation is not covered by the warranty.

Mounting the Riflescope

1. For initial fitting of the riflescope to the rifle, set the Nightforce riflescope to the highest magnification. Place the riflescope in the lower portion of the rings as far forward as possible. Install both ring tops. Tighten ring top screws with just enough tension to hold the riflescope where positioned, while still allowing smooth movement fore and aft and rotationally.

2. Hold the rifle in your normal shooting position with the riflescope positioned fully forward in the rings, preferably while adjusted to maximum magnification. Place your head as far forward on the stock as you might position it in field use. Slowly move the riflescope back just to the point where the full field of view is obtained. It is recommended to mount the riflescope at this position with as much eye relief as possible (3.5"–4") or slightly forward to ensure maximum eye relief. See Figure 6.

Note: Please see warning on page 8 regarding sufficient eye relief. Eye relief will change with the thickness of the clothing you wear and may need to be readjusted.

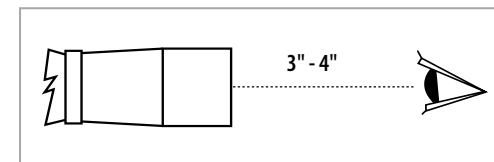

Figure 6:
Eye relief

Leveling the Reticle

For precision shooting, the reticle and the rifle need to be squared, or plumb, to each other. Any out-of-square condition can cause sighting errors that will be magnified even more at longer distances.

The reticle in all Nightforce scopes is confirmed plumb with the flat surface on the bottom of the adjustment saddle. See Figure 7. You can use pin gauges, a sliding sine bar or flat shims to align the flat surface with the top of the

scope rail. To level the reticle using a plumb line, follow these steps:

1. Level the rifle on a steady rest such as sandbags or a stable shooting rest. This can be accomplished with a bubble level attached to the riflescope base, or on a flat section of the action.
2. Use a plumb line or some other known plumb vertical line at a distance from the rifle where you can see it clearly through the riflescope. A distance of 100 yards is recommended, but good results can often be obtained as close as 50 yards.
3. Center the reticle on the plumb line and rotate the riflescope in the rings until the vertical line of the reticle is parallel with the plumb line. Recheck the rifle level and adjust the reticle position as needed. When both the rifle and the reticle are plumb, tighten all ring top screws evenly until the riflescope is secure in the rings. Recheck the rifle and reticle one more time for plumb, adjust as needed, then torque the screws to the recommended torque settings. Your Nightforce riflescope is now properly mounted.

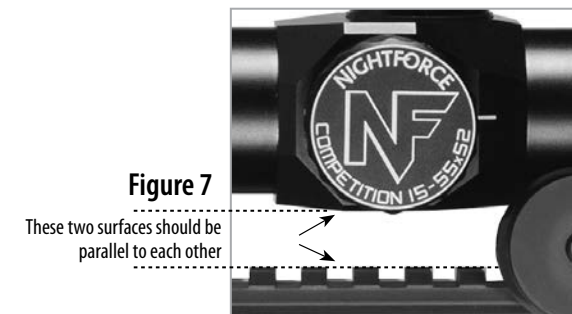

Figure 7

These two surfaces should be parallel to each other

Establishing a Sight-in Zero

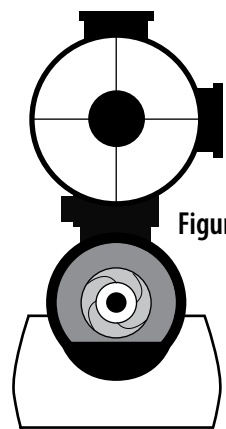

Figure 8

A quick way to get your first shot on target with a new installation is to first bore sight the riflescope. A simple yet reliable method is by looking through the bore at a round, high contrast target, approximately 5"–6" in diameter, that can be seen clearly with the naked eye at either 25, 50 or 100 yards/meters, yet is small enough to "float" in the center of the rifle bore when viewed through the opened action. This can save you time and ammunition.

1. Ensure that the rifle is unloaded and the chamber is empty. Remove the bolt and place the rifle on a steady rest.
2. Looking through the bore from the action end, center the round target downrange so that it is floating in the center of the bore, then adjust the elevation and windage adjustments until the reticle is centered on the target while the target is still centered in the bore. See Figure 8.
3. If you feel confident in the bore sighting, proceed to live firing at 25, 50 or 100 yards/meters. To aid in the sight-in process, be sure your sight-in target is large in size, and offers a contrasting color (i.e., white). After confirming point of impact, proceed to step four. Note: if you have sighted in at 25 yards/

meters, you will need to move the adjustments four times more than you would with a 100 yard/meter sight-in. If you sighted in at 50 yards/meters, you will need to move the adjustments two times more than you would with a 100 yard/meter sight-in. If the first shot isn't on target, recheck your bore sighting and/or move to a 25 yard/meter sight-in distance.

4. Without changing the adjustments, move the rifle to center the reticle on the target. Carefully turn the windage and elevation adjustments without moving the rifle, until the reticle is aligned on the center of the bullet hole from that first shot on the target.
5. Fire at least a three-shot group at the desired close-range zero distance, then fine-tune your zero as needed.

Zeroing Adjustments (Precision Benchrest)

The elevation and windage adjustments can be set to the zero position on the number dial once you have zeroed the riflescope. To do this, unscrew the dust cap, then loosen the set screws on the elevation and windage adjustments using the supplied Allen wrench, allowing the dial to turn freely without changing the actual setting. Align the zero point on the number scale engraved in the adjustment with the center line engraved on the rotation scale underneath the adjustment. See Figure 9.



Figure 9

Keep downward pressure on the knob while tightening the set screw with the Allen wrench, holding the wrench only by the short end when tightening. Do not overtighten to prevent damaging the components inside (approx. 4 inch pounds). Note that you cannot zero both the dial and the horizontal rotation scale so they both read "zero" because the horizontal rotational scale is meant to indicate the number of revolutions up from the bottom. Remember to record the rotations so you know what rotation your zero is on.

ZeroStop™ Elevation Adjustments (Competition™)

Please visit www.NightforceOptics.com for a step-by-step video tutorial on this process and advanced setting methods that can maximize the performance of your ZeroStop™-equipped Nightforce riflescope.

After you have determined the ammunition that performs best for your intended use and established the zero/sight-in, please follow these instructions:

1. Remove elevation turret cap by loosening the set screw 1 to 2 turns but do not remove the screw entirely. The dial should rotate freely and no adjustment "clicks" should be felt. See Figure 10.

2. Lift the cap upward with a slight twisting motion to remove it from the body. You should feel slight resistance but not feel any "clicks". Set the cap aside on a clean surface.
3. You have now exposed the ZeroStop™ clutch assembly. Take care to maintain the cleanliness of the inside of the cap and the clutch area. Do not remove any of the lubricating grease. See Figure 11.
4. Loosen each of the four Allen head screws on the ZeroStop™ clutch assembly 1 to 2 turns, until they are flush with the top of the clutch assembly. DO NOT remove the screws from the clutch assembly.



Figure 10



Figure 11

5. To set the ZeroStop™ clutch assembly, rotate the upper clutch face downward/clockwise until it is firmly against the lower clutch face. Note: You should not feel any “clicks” or resistance while making this adjustment. See Figure 12.

6. While holding the clutch mechanism in position, tighten the four Allen head set screws on the clutch assembly evenly in an “X” pattern. Do not over-tighten the screws as this can damage the clutch assembly. Tighten one screw until you feel slight resistance, then move to the next screw in the “X” pattern. Continue to do the same for all four screws. Now repeat the “X” pattern and tighten the screws to 4 inch-pounds. If no calibrated torque driver is available, hold the short end of the Allen wrench to tighten the screws and only use your thumb and finger to turn the wrench. This will provide sufficient torque. See Figure 13.

7. To reinstall the adjustment cap, center it over the adjustment body, and press down lightly while turning the adjustment cap clockwise until it moves into position. Keep downward pressure on the adjustment cap as it may tend to move up due to the compressed air resistance created by the O-ring seal. Align the “0” (zero) fixed index mark on the engraved scale of the adjustment cap with the center line on the scope body (Figure 14) and tighten the set screw to 4 inch-pounds (Figure 15).

NOTE: If no calibrated torque driver is available for 4 inch-pounds, hold the short end of the Allen wrench between your thumb and finger to turn the wrench and tighten to slight resistance.



Figure 12



Figure 13



Figure 14



Figure 15

Caring for Your Rifle Scope

With proper care your Nightforce riflescope will give you many years of dependable service. Be sure to use your lens covers whenever you are not using your riflescope.

Cleaning the Rifle Scope Exterior

Clean the riflescope body with a clean cloth lightly moistened with clean water or alcohol. Do not use strong solvents. While cleaning your rifle, be sure to protect your riflescope's lenses by installing the covers that came with the riflescope (or equivalent covers). Ammonia-based bore solvents can destroy the coating on the glass. Avoid spilling gun cleaning solvents anywhere on the riflescope.

In the event of submersion in mud, sand, dirty or salt water, flush the outside of the riflescope with clean water to remove encrusted material and salt. If your riflescope came with screw-on adjustment covers, install them before flushing with water. Wipe the outside metal surfaces dry with a soft cloth then proceed to the step below.

Cleaning Lenses

We recommend using a Nightforce cleaning kit A130 to care for the lenses on your riflescope. The kit contains an ultrasoft brush, microfiber cloth and cleaning solution.

With the lens facing down to allow the debris to fall away from the surface, remove loose dirt and dust with compressed air and/or a lens brush. Do NOT

use high-pressure compressed air from cans (such as found in office supply stores). They can, and have, been known to destroy lens coatings. If there is grit stuck to the lens that won't come off with the compressed air or a brush, flushing the surface with alcohol or distilled water will prevent that grit from being rubbed into the glass by the cleaning swabs.

Using a soft, clean, lint-free cotton swab or lens cleaning cloth, and lens cleaning fluid applied to the swab, clean the lens starting in the center, working to the outside in a circular motion. Make only one pass to the edge where the glass meets the metal. Once you reach the edge of the lens, do not re-use that swab as it will often contain abrasive grit that will scratch the surface. Start over in the center with a new swab and repeat the process until the glass is clean. Use a very small amount of cleaning solution for the last pass to prevent streaks.

Long Term Storage

If the riflescope will not be used for an extended period, remove the battery (Precision Benchrest models) and store it separately. Keep the riflescope in a cool, dry, dust-free location.

For a list of frequently asked questions, video instruction, information on service and on Nightforce accessories, visit www.NightforceOptics.com.

Online warranty registration: Visit www.NightforceOptics.com/WarrantyRegistration to activate your warranty, register for Nightforce gear and to receive updates and future product support.

Nightforce accessories



30mm for Rem 700



30 & 34mm

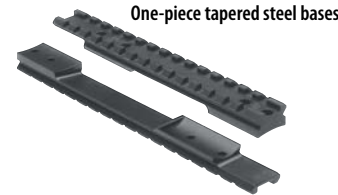

Two-piece tapered steel bases



30 & 34mm



ADI & bubble level

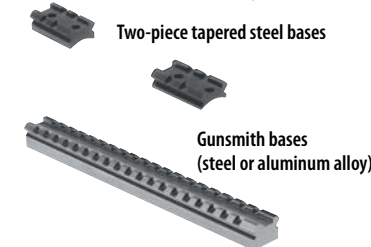

Gunsmith bases (steel or aluminum alloy)



30 & 34mm



30 & 34mm

Steel rings (30mm)



Ultralite™ aluminum/titanium rings (30mm & 34mm)

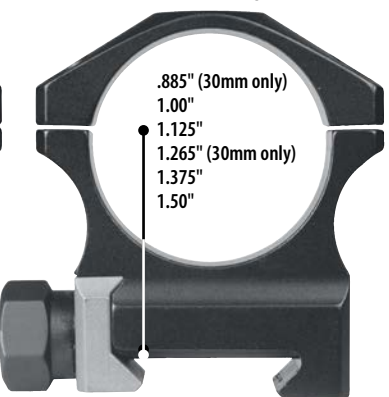

About the only way to improve on a Nightforce riflescope is with genuine Nightforce accessories. Our Ultralite™ rings, Unimount™, and MagMount™, for example, provide the performance of steel at half the weight. They are precisely machined, and combined with a Nightforce riflescope, give you the most effective, reliable investment in precision shooting possible.

Visit www.NightforceOptics.com for complete information.



Cleaning kit



Nightforce apparel



We are proud to back up Nightforce ATACR™, B.E.A.S.T.™, Benchrest, Competition™, NXS™ and SHV™ riflescopes with a transferable Limited Lifetime Warranty which covers mechanical defects in materials and workmanship in the optical and mechanical components of the riflescope. In the event of a defect in materials or workmanship that is covered by this warranty, we will either repair the riflescope or replace it at no charge, with a comparable product at our discretion.

Exclusions to this warranty include intentional or accidental damage, abuse, misuse, unauthorized modifications or repairs, and improper mounting. This warranty does not cover any consequential or incidental damages resulting from the inability to use the riflescope. Any serial number obliteration or alteration on the product will void the warranty. SHV™ models maintain waterproof integrity with their protective caps installed.

To ensure warranty coverage, please register online or fill out completely and mail in the provided warranty card found in the back of the owner's manual, along with a copy of the sales receipt. The warranty begins on the date the product was purchased by the original owner. The optical and mechanical components are covered without time limitations. The riflescope's electronic components are covered for a period of three years.

This warranty gives you specific legal rights, and you may also have other rights which vary from state to state. Some states do not allow the exclusion or limitation of incidental or consequential damages, so the above limitations or exclusions may

For the latest updates and information regarding our products, visit www.NightforceOptics.com.

not apply to you. Some states do not allow limitations on how long an implied warranty lasts, so the above limitations may not apply to you.

Before sending a riflescope in for service, please call Nightforce Optics, Inc. at the number below, to determine if the problem can be resolved without sending us the product. All returns must be accompanied by a Return Merchandise Authorization (RMA) number. Failure to do so can result in lost merchandise and/or severely delayed service time.

- Remove any mounting rings or accessories other than dust covers and the original sunshade.
- Record and keep on hand the serial number.
- Include with the riflescope a detailed description of the defect(s), the RMA number, your name, phone number and the address you wish the riflescope returned to.
- Place the boxed or protectively wrapped riflescope in a well-padded outer box insured for replacement value and send it shipping prepaid, to the appropriate address below. **Write the RMA number on the outside of the package.**

U.S.A. & Canada:
Nightforce Optics, Inc.
Attention: Service Dept.
 336 Hazen Lane
 Orofino, Idaho 83544
 tel 208.476.9814
 fax 208.476.9817
www.NightforceOptics.com

International:
Nightforce Optics
Attention: Service Dept.
 28 Orsmond Street
 Hindmarsh, SA 5007 Australia
 tel +61 (0)8 8440 0888
 fax +61 (0)8 8346 0504
www.NightforceOptics.com

Be sure to register your warranty at
www.NightforceOptics.com/WarrantyRegistration

A reticle for every reason.

Nightforce offers the most extensive selection of proprietary reticles on the market. We make highly precise MOA- and MIL-based designs, fast and accurate reticles for big game hunting, and our unique Velocity™ reticles tailored to the ballistic profile of your rifle.

We can generally retrofit a newer reticle to an older Nightforce riflescope (assuming it is offered in the same model riflescope that you own).

The clarity, resolution, brilliance and ruggedness of a Nightforce riflescope is only part of the accuracy equation. A reticle created for ultimate performance in your chosen application is the other essential component.

We have a reticle for every reason. And every season.



Visit www.NightforceOptics.com to learn more.

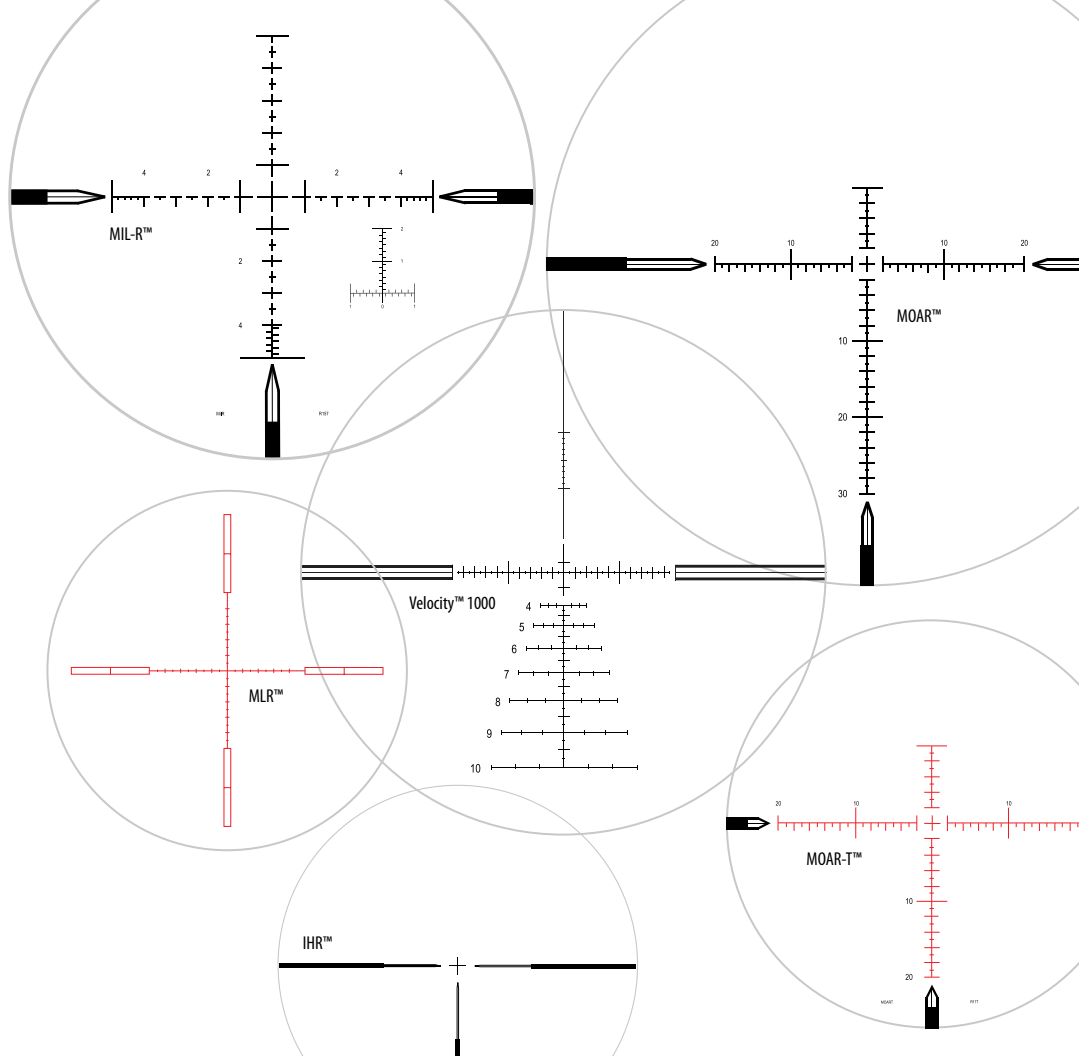

Please detach here

Nightforce Warranty Registration Card

Activate your warranty at www.NightforceOptics.com/WarrantyRegistration and be eligible for product support, updates and additional Nightforce gear. If you do not have Internet access, please tear out, fill in and return this product registration card within 30 days of purchase. Return to the address below along with a copy of your purchase receipt. We retain this card for warranty eligibility.

Name: _____

Address: _____

City: _____ State: _____ Zip: _____

Phone No.: _____ Email: _____

Model: _____ Serial No.: _____

Date of Purchase: _____ Purchased From: _____

Please take a moment to provide your comments on the following page.

To locate your serial number:
 NXS™ Compact and NXS™ F1 and B.E.A.S.T.™ scopes: On the top of the tube body, in front of the elevation adjustment. SHV™: On the bottom of the elevation/windage/parallax adjustment saddle. NXS™ 15x, 22x, 32x, 42x, ATACR™, Benchrest and Competition™ scopes: On the bottom of the tube body in front of the power change ring. If you have already mounted the riflescope and cannot find the serial number, it is probably covered by the scope rings.

Attach a copy of your receipt and send to: **Nightforce Optics, Inc.**
 336 Hazen Lane
 Orofino, Idaho 83544

Register online at
www.NightforceOptics.com/WarrantyRegistration

Nightforce Owner's Comments

Your feedback and suggestions will help us maintain the high level of quality and customer service Nightforce owners have come to expect. We encourage your input.

Why did you choose Nightforce? _____

What changes or modifications would you recommend be made to improve this product? _____

What new products would you like to see offered by us? _____

What hunting/shooting magazines do you normally read? _____

What hunting/shooting television programs do you like to watch? _____

Do you participate in Internet forums or blogs? Which ones? _____

How did you hear about Nightforce products? _____

Are you a member of a local rifle shooting club or range? Yes No Do you participate in any of the following competitive shooting events?

If so, please check the appropriate box: Long-range benchrest Short-range benchrest F-Class Precision tactical 3-Gun Tactical

Other (please explain) _____

Do you travel to participate in competitive shooting events? Yes No If so, how far do you typically travel? ___Miles ___Hours

Please detach here



We'd like you to meet our sister.

For over 25 years, our sister company, Lightforce Performance Lighting, has been building some of the highest quality, most robust and brilliant hand-held sporting and driving lights in the world.

Lightforce is headquartered in Australia, where the demand for sporting and off-road driving lights is high, and the conditions they must endure are fierce. The complete Lightforce product line is now available in the United States.

Lightforce shares the same commitment to excellence in performance and design in its lighting systems as does Nightforce with our riflescopes. If you have an interest in lighting your night, we invite you to spend some time at www.Lightforce.com and see everything our sister can do. She's extremely bright.

www.Lightforce.com

Light 'em up!™

Lightforce Driving Lights
Maximum light, maximum durability for off- and on-road vehicles. Proven in the most brutal racing challenges from Baja to Dakar. Unique filter system adapts a single light to any environment you could encounter.



Striker 170

Our most popular sporting light. Light in weight, comfortable to use, virtually unbreakable and supremely bright. Offered in several configurations for handheld, vehicle, portable, marine and gun-mounted use.

PRED9X™

Winner of the prestigious 2013 Australian International Design Award. Quick-release mount attaches to almost any riflescope with 25mm, one-inch or 30mm tube. Identify targets to 250 yards in the dead of night. Wireless control, rechargeable Li-Ion batteries. There's no hiding from a PRED9X.

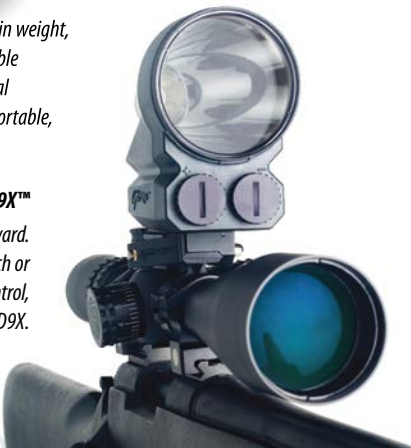



NIGHTFORCE®

FCR-1™

**Factory/Headquarters U.S.A.
Customer Service, Technical & Warranty:**

Nightforce Optics, Inc.
336 Hazen Lane
Orofino, ID 83544
tel 208.476.9814 • fax 208.476.9817
info@nightforceoptics.com

North American Dealer Sales:

Nightforce Optics, Inc.
2749 Providence Church Road
Lavonia, GA 30553
tel 706.434.8950 • fax 706.449.0930
dealersales@nightforceoptics.com

Military, Government & Law Enforcement:

Nightforce Optics, Inc.
2749 Providence Church Road
Lavonia, GA 30553
tel 706.434.8953 • fax 706.449.0931
militaryinfo@nightforceoptics.com

European, Asian & African Sales:

Nightforce Optics, Inc.
2749 Providence Church Road
Lavonia, GA 30553
tel 706.434.8952 • fax 706.449.0930
intlsales@nightforceoptics.com

Australian & South Pacific Sales:

Nightforce Optics
28 Orsmond Street
Hindmarsh, SA 5007 Australia
tel +61 (0)8 8440 0888
fax +61 (0)8 8346 0504

International Warranty & Service:

Please contact your country's authorized Nightforce Optics distributor and/or retailer for instructions. A list of international distributors and dealers can be found at www.NightforceOptics.com.

All trademarks, graphics and designs herein are the property of Nightforce Optics, Inc. Product specifications are subject to change without notice. Products may differ in appearance from those shown here; not responsible for typographical errors. Visit www.NightforceOptics.com for current information, tutorials, and video. Lightforce USA, dba Nightforce Optics, Inc. ©Nightforce Optics, Inc. 2014 3/14