

User Manual

TERRAPIN

English, Version 1.0
VII 2010

vectronix 

Purpose of Equipment

The TERRAPIN is a pocket size, handheld, button operated laser rangefinder with an internal sighting optic and range display.



For safe use of the device, please note the safety directions included in the User Manual.

© 2010 Vectronix AG, ® All rights reserved.

Table of Contents

| | |
|---|-----------|
| General Information | 5 |
| Safety Notices | 5 |
| Care and cleaning | 7 |
| Technical Data | 8 |
| Getting started | 11 |
| Changing the batteries | 11 |
| Diopter adjustment | 12 |
| Reticle | 13 |
| General Operations | 14 |
| Distance Measurements | 15 |
| Factors affecting measurement range | 15 |
| Slope distance | 16 |
| Multiple object measurement | 17 |
| Configuration | 18 |
| Making adjustments | 18 |
| Measuring 3 distances | 19 |
| Night vision device | 19 |
| Settings | 20 |

| | |
|---|-----------|
| Measurement units | 20 |
| Distance gate | 21 |
| Set Factory Settings - Reset to default | 22 |
| Built-in-Test | 23 |
| Troubleshooting | 24 |
| Equipment | 26 |
| Parts List | 26 |
| Accessories | 27 |
| Customer service | 28 |
| Quality system | 29 |

General Information

Safety Notices

Safety Class: 1

IEC 60825-1 Ed 2.0 (2007-03)

ANSI Z 136.1 (2007)

according to:



Nominal Ocular Hazard Distance

Unaided eye 0 meter

Aided (7 x 50 binocular) 0 meter

Inappropriate use

- Device deployment without prior knowledge of the operating instructions and safety notices.
- Changes and modifications to the device by the customer.
- Use of third-party accessories not expressly approved by Vectronix AG.

Inappropriate use brings the risk of

- injuries;
- instrument errors;
- damage to property;
- malfunction;

Blinding hazard

- Do not look into powerful light sources with the device.
- Do not open the device. The built-in laser can cause eye injuries.

Explosion hazard

The battery must not be

- short-circuited;
- recharged;
- mechanically modified;
- placed in fire or heated above +85°C with the device.

Caution:

Use of controls or adjustments or performance of procedures other than those specified herein may result in hazardous laser light exposure.

Care and cleaning

The device's performance and serviceability are conditional on regular care and immediate attention to problems:

- Do not touch glass lenses with fingers.
- Do not soil the operating keys with oil or grease.
- Avoid abrupt temperature transition, since these can cause condensation moisture to develop inside the device.

The device does not need special care or cleansers.

Therefore

- do not use any kind of impregnated cloth intended for cleaning spectacle lenses,
- do not use any solvent except water, e.g. no alcohol or cleansers.

Lens cleaning

Particles of dirt should be blown off or removed using a soft brush.

Finger prints may be cleaned first by wiping with a damp cloth, followed by soft, clean optical tissue or chamois leather.

Cleaning the casing

Wipe the casing with a damp cloth. Pay special attention to dirt and grease around the keys.

Blow out the device interface cable socket, and clean it carefully.

Allow the device to dry fully before packing.

Technical Data

Optics

| | |
|------------------------------|-------------|
| Configuration | monocular |
| Magnification | 5x |
| Objective diameter | 24 mm |
| Field of view | 142mil / 8° |
| Focus | fixed |
| Dioptric setting | +/-4dpt |

| Rangefinder | TERRAPIN |
|-------------------------------|------------------------------|
| TERRAPIN Laser type: IR diode | 905 nm |
| Eye safety | Class 1 |
| Standard | IEC 60825-1 Ed 2.0 (2007-03) |
| Range Performance | 20m - 2400m |
| Specified Performance | 1800m* |
| Accuracy (1 σ) | \pm 3m |
| Beam divergence | 0.4 x 2.4mil |
| Display Resolution | 1m / 1ft / 1yd |

* at visibility 30km, 2.3 x 2.3m target size, albedo 0.6, detection probability >90%

Miscellaneous

| | |
|---|------------------------------------|
| Power supply | 2x 3V lithium battery, type CR123A |
| Battery capacity | > 7000 measurements |
| Immersion | 1m, 1h |
| Operational temperature range | -35°C to +63°C -31°F to +145°F |
| Storage temperature range (without battery) | -40°C to +85°C -40°F to +185°F |
| Weight with batteries | 500g |
| Dimensions | |
| length | 128mm / 5.0in |
| width | 104mm / 4.1in |
| height | 47mm / 1.9in |
| Tripod interface | 1/4 inch thread |

Getting started

Changing the batteries

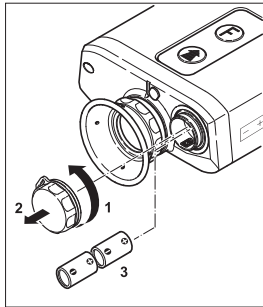

Open the battery compartment.

Insert two lithium batteries type CR123 with +(positive) pole ahead.

Refit the battery cover. **Tighten it completely until it stops.**

The device monitors the condition of the batteries. If the display shows "LobAt", this indicates that the batteries are used up. You can still get readings, but the batteries need to be replaced.

The "LobAt" display may also appear under cold conditions, since low temperature reduces the performance of the batteries.



Remove batteries before storing.

Diopter adjustment

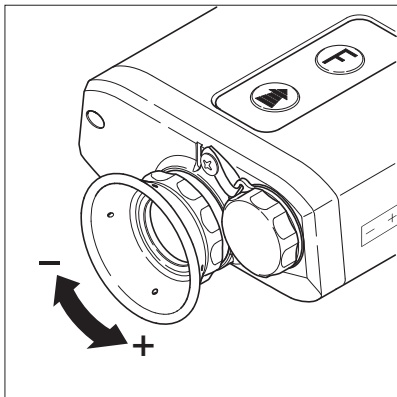

Sight on an object farther than 100 m away and rotate the eyepiece to obtain a sharp image.
Standard setting: 0



If the device is being used by different people, remember your personal diopter setting.

Reticle

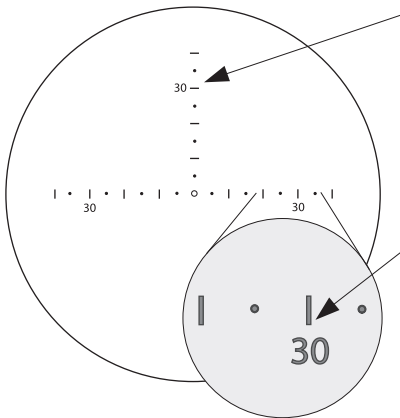

Engraved reticle

Line spacing: 10 mils

Line-point spacing: 5 mils



1 mil corresponds to 1 m spacing at a distance of 1 km.

Illuminated reticle

An illuminated reticle can be activated for the use under poor lighting conditions.

To activate the illuminated reticle press and hold the distance button for at least one second.

General Operations

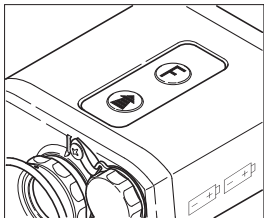

The device is operated entirely by means of the two keys.

F : function key

 : distance key

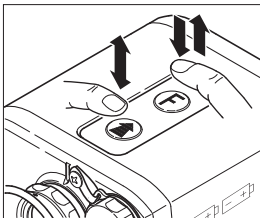

Key operation is indicated by the following symbols:

 press and hold key

 release key

 press and release key (click)

Hold the device steady during measurement.
The device displays the measurement result, then switches itself off automatically after a few seconds.



You can prolong the display period by holding down the range key while the result is displayed.

Distance Measurements

Factors affecting measurement range

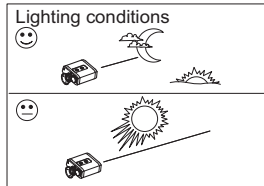
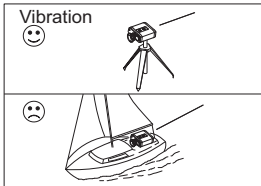
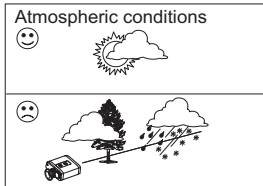
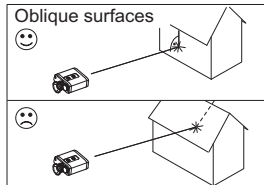
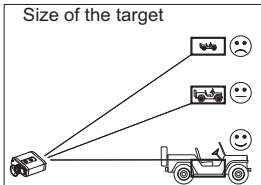
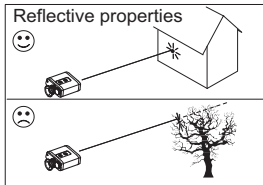

Slope distance

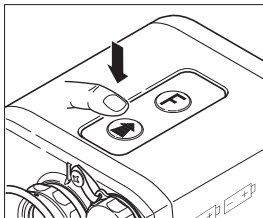

Press and hold the distance key.



To activate the illuminated reticle, press the distance button for at least one second.

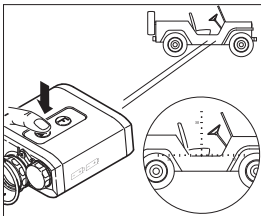

Sight the object with the reticle.

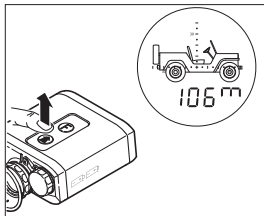

Hold the instrument steady as you release the key. The slope distance appears. If "----" is displayed, the object lies outside the measuring range or the measuring conditions are poor.

Multiple object measurement

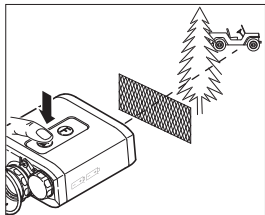

Up to three separate distances in the line of sight can be obtained with a single measurement.

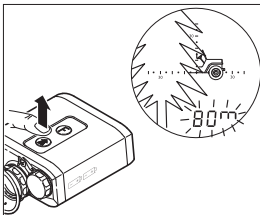

To use this feature, "3dOn" must be activated via the configuration menu (see page 18)
A flashing display indicates that more than one distance has been detected.

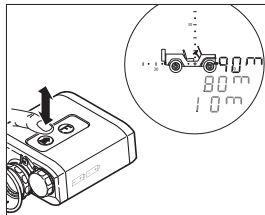

Click the distance key repeatedly to scroll through all obtained distances.
The order of the displayed ranges is: nearest, second nearest and farthest detected distance.

Configuration

Making adjustments

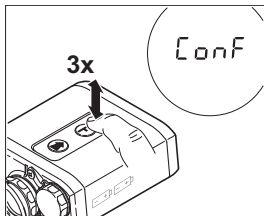

Various instrument functions are switched on and off via the configuration menu. Click the function key three times in rapid succession. "ConF" appears for a short instant.

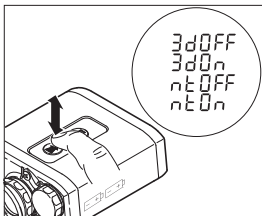

Click the distance key until the desired setting appears.



The various functions are described in detail on the following pages.

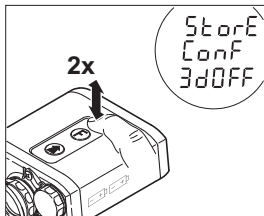

Click the function key two times in rapid succession to save your setting. The setting is not changed when "OldC" is displayed.

Measuring 3 distances Night vision device

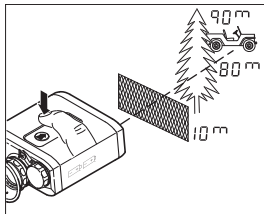

Function: 3dOn / 3dOFF

"3dOn" allows to obtain up to three distances in the line of sight with a single measurement (see page 17)

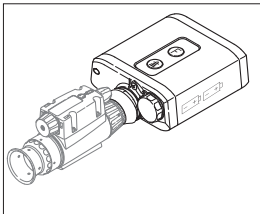

Function: ntOn / ntOFF

"ntOn" reduces the display brightness, which is needed only in combination with an attached night vision device.



If the function is set to "ntOn" and the device is used in daylight conditions, the message "ntOn" is displayed for a short instant. (see page 25)



The laser flashes from the laser range finder can be seen during the process of measurements through the night vision device. It is innocuous for the eyes.

Settings

Measurement units

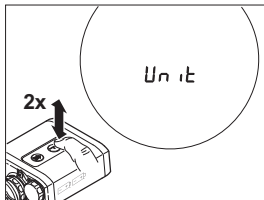

Meters, yards or feet can be selected as measurement unit.

Click the function key two times in rapid succession.
"Unit" appears briefly.

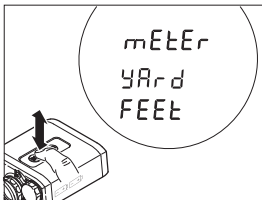

Click the distance key until the desired unit appears.

"mEtEr": Meter
"YARd": Yard
"FEET": Feet

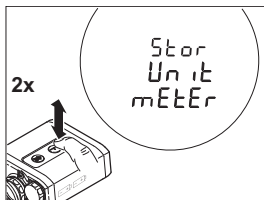

Click the function key two times in rapid succession to store the selection.

The setting is not changed when "OldU" is displayed.

Distance gate

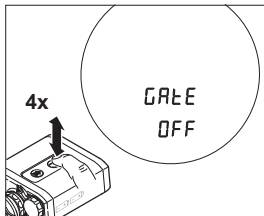

In certain cases, it may be useful to limit the closest distance the device will measure.

Click the function key four times in rapid succession. "GAtE" appears briefly followed by the current setting. (e.g. "OFF")

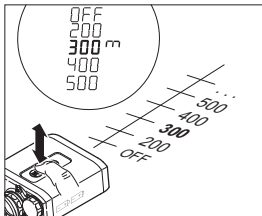

Click the distance key until the desired minimum distance appears (e.g. 300m)

Setting "OFF" disables the distance gate.

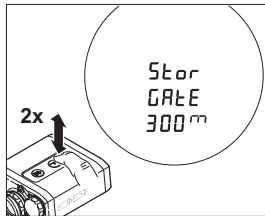

Click the function key two times in rapid succession to store the setting. The setting is not changed when "OldC" is displayed.



"GAtE" is displayed briefly when closer ranges are measured.

Set Factory Settings - Reset to default

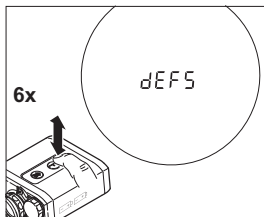

Click the function key six times in rapid succession. "dEFS" for default settings.

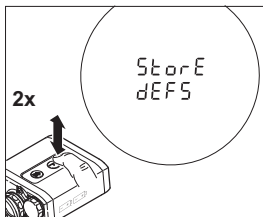

Click the function key two times again to store the default factory settings. "StorE" - "dEFS" appears.
If not done correctly, the settings remain unchanged and "OldC" is displayed.

The default factory settings are:
Distance gate "off"
Night mode "off"
Multiple object measure. "off"
Distance unit "meter".

Built-in-Test

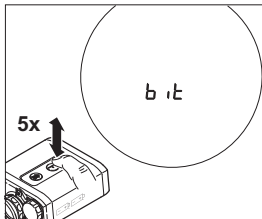

Click the function key five times in rapid succession. "bit" appears briefly, the built in test starts automatically.

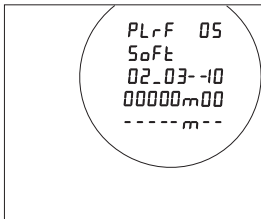

1. Model "PLrF05"
2. Software version "Soft" (e.g.02-03-10)
3. Display Test "00000m00"
"-----m--"
4. Memory test "MEM" "Good" or "bad"

5. Flash Test "FLASH" "Good" or "bad"
6. Voltage Test "voLt" "Good" or "bAd"
7. BIT finished "bit" "End"

Troubleshooting

| Problem | Possible cause | Solution |
|--|---|--|
| Measurements can not be taken - no function at all | The batteries have run out Battery contacts corroded Low temperature reduces performance of batteries Extreme heat shortens batteries life | Replace batteries (see page 11) Clean battery contacts Warm up batteries Do not store the batteries at temperature over +85°C |
| "- - -" is displayed after distance measurement | Distance is outside the specified range Object too small or inaccurately targeted Bad weather conditions | Respect specified measurement range (see page 9) Respect factors affecting measurement range (page 15) |

| Problem | Possible cause | Solution |
|--|---|--|
| "LobA" is displayed | The battery is almost used up | Replace battery (see page 11) |
| The device measures objects in front or behind the intended object | "3dOFF" is set in the configuration menu, only the distance with the highest return signal is displayed | Select "3dOn" in the configuration menu (see page 18) |
| "ntOn" is displayed after a measurement | The device is used during daylight conditions with "ntOn" selected in the configuration menu | Select "ntOFF" in the configuration menu (see page 18) |

Equipment

Parts List

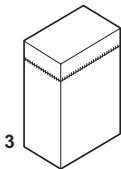
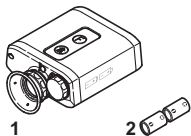

Standard extent of delivery:

- | | |
|---|---|
| 1 | TERRAPIN |
| 2 | 667 002 SEB51 lithium battery, 3V, CR123A (2x required) |
| 3 | 907 650 Pouch |

Spare parts:

- | | | |
|---|---------|---------------|
| 4 | 905 494 | Eye cap |
| 5 | 907 702 | Battery cover |
| 6 | 725 020 | Lanyard |

Accessories

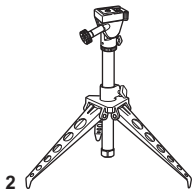
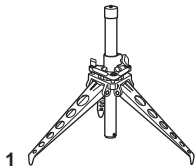

Optional:

- 1 664 868 SST3-1 mini-tripod, non magnetic
- 2 729 452 SST3-2 mini-tripod, non magnetic with pan/tilt head

Customer service

Our customer and information service will be glad to offer assistance if your instrument requires maintenance, if it sustains damage, or if you require any other information:

Vectronix AG
Max-Schmidheiny-Strasse
CH-9435 Heerbrugg
(Switzerland)

Telephone: +41 71 726 72 00
Fax: +41 71 726 72 01
Internet: www.vectronix.ch

Copyright

Without the prior written permission of Vectronix this document may neither be copied in part or whole by mechanical, photographic, electronic or any other means (this includes converting it to any machine-readable form), nor be stored in an information storage system, nor be used for any purpose other than that intended, nor be made available or passed on to any third party who has not been expressly authorised by Vectronix.

Quality system

SQS certification attests that Vectronix operates a quality management system that complies with international standards for quality and quality management systems (ISO 9001) and environmental management systems (ISO 14001).



Total Quality Management - our commitment to total customer satisfaction. Ask your local Vectronix representative for more information about our TQM programme.

DOC Code: 909111-1.0en

Printed in Switzerland

Copyright by Vectronix AG,

Heerbrugg, Switzerland, VI 2010

vectronix 

Vectronix AG

CH-9435 Heerbrugg

(Switzerland)

Telephone +41 71 726 72 00

Fax +41 71 726 72 01

www.vectronix.ch