

Owner's Manual  
NXS™ 1-4x Compact  
NXS™ 2.5-10x Compacts

NF

NXS™ COMPACT



**NIGHTFORCE®**

2013 V2

## Contents

Nomenclature and features .....	3
Focusing the reticle .....	4
Elevation and windage values .....	5
Parallax adjustment (2.5-10x42 only) .....	5
Reticle illumination.....	6
Battery replacement .....	7
Installing the riflescope .....	8
Leveling the reticle.....	10
Establishing a sight-in zero.....	11
PTL™ (Power Throw Lever) .....	11
Zeroing adjustments .....	12
ZeroStop™ elevation adjustments (optional).....	13
Caring for your riflescope.....	15
Warranty and service.....	16
Warranty registration card .....	17
Owner's comments.....	18

Record the riflescope serial number here for future reference: \_\_\_\_\_

### WARNING!



*Make sure that your rifle is not loaded before proceeding. Reconfirm that the chamber is empty if you stop the procedure then resume later.*

Register your warranty at  
[www.NightforceOptics.com/WarrantyRegistration](http://www.NightforceOptics.com/WarrantyRegistration)



## NIGHTFORCE

Nightforce Optics, Inc.  
 336 Hazen Lane  
 Orofino, ID 83544  
 tel 208.476.9814 • fax 208.476.9817  
 info@nightforceoptics.com • www.NightforceOptics.com

## Nomenclature and features

# NXS™ COMPACTS

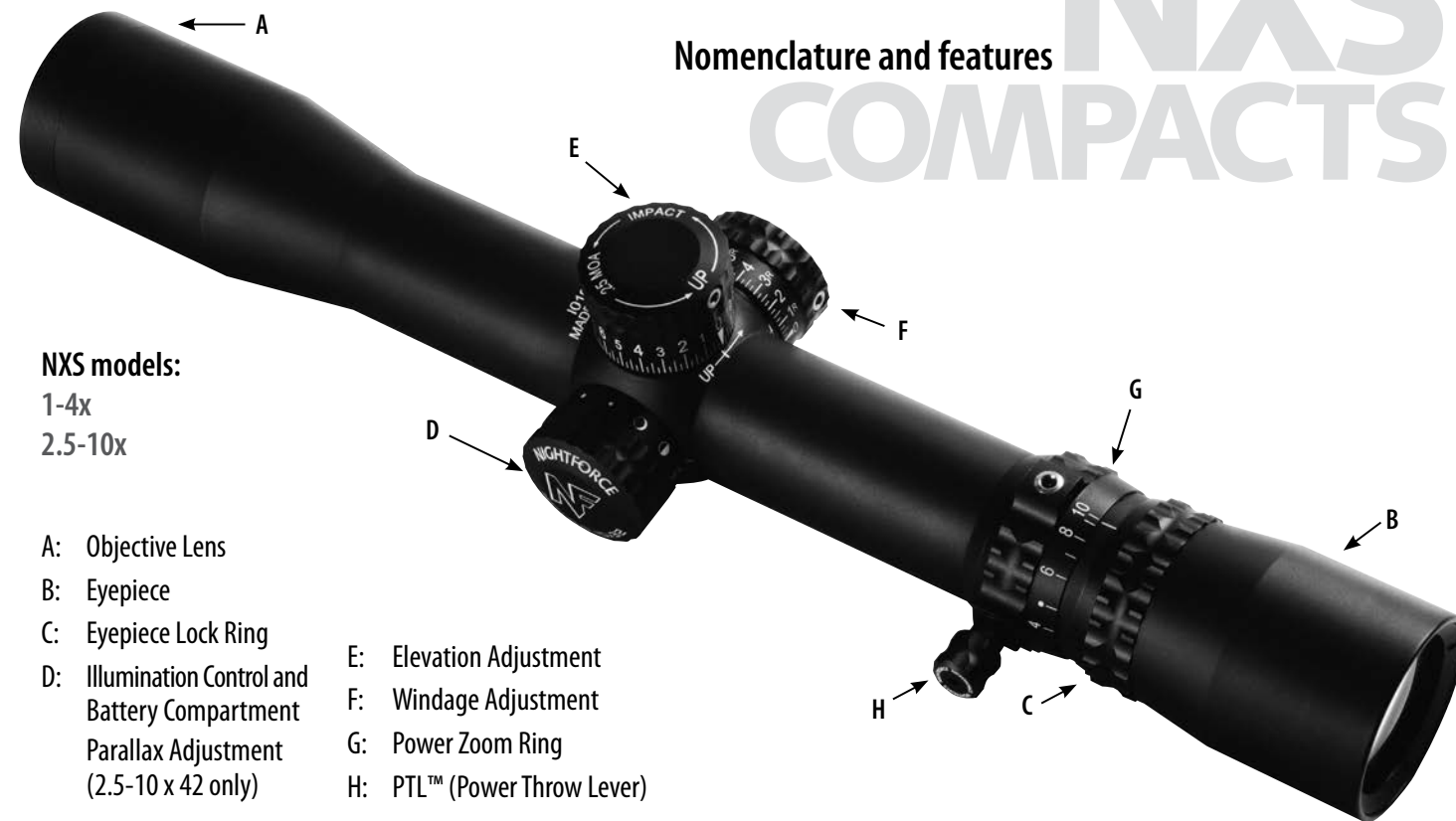

### NXS models:

1-4x  
 2.5-10x

- |   |                             |
|---|-----------------------------|
| A: Objective Lens                               | E: Elevation Adjustment     |
| B: Eyepiece                                     | F: Windage Adjustment       |
| C: Eyepiece Lock Ring                           | G: Power Zoom Ring          |
| D: Illumination Control and Battery Compartment | H: PTL™ (Power Throw Lever) |
| Parallax Adjustment (2.5-10 x 42 only)          |                             |

Product specifications, features, appearances and information subject to change without notice. For the latest updates and information regarding our products, visit [www.NightforceOptics.com](http://www.NightforceOptics.com).



## WARNING!

*To avoid permanent eye damage or blindness, do not look directly at the sun or other extremely bright lights through the riflescope.*

## Focusing the Reticle

The reticle focus is used for setting the reticle focus to match your particular vision. It should not be used to try to focus for parallax. NXS™ 1-4x and 2.5-10x32 Compact riflescopes do not have adjustable parallax; the 2.5-10 x 42 does. If you plan to wear vision correction when shooting, then set this focus while wearing your corrective lenses. Record the number of turns you have made on the eyepiece from the original factory setting so you can return to it if needed.

**Note:** All Nightforce riflescopes are factory set for average eye strength, so this adjustment may not be necessary.

1. Set the power zoom ring at the highest magnification.
2. Look through the riflescope eyepiece at a light colored background such as a white wall, overcast sky, or drape a thin white cloth over the objective to eliminate background clutter. Determine if the reticle is clear and in focus instantly when you look through the eyepiece. Be aware that staring at the reticle for more than two seconds during this process will cause your

eye to compensate, resulting in a false indication of reticle focus. Look away for a few seconds then retry for best results. You are looking for a sharp, crisp and well defined reticle image.

3. If adjustment is necessary, follow the steps outlined for the type of Nightforce riflescope you have. Due to the way the human eye focuses, best results are usually obtained by turning the eyepiece inward until the reticle is slightly blurred then moving it outward until sharp focus is obtained. Refer to Figure 1.

### Reticle Focus Adjustment

Grasp the eyepiece with one hand and the locking ring with the other and rotate the eyepiece counter-clockwise, turning it away from the lock-ring while holding the lock-ring, power zoom ring and the riflescope to keep them from turning with the eyepiece. Several turns of the eyepiece may be necessary to achieve any measurable difference. To achieve an out-of-focus starting point for your vision, you may need to turn the lock-ring several turns inward first, then turn the eyepiece inward as needed to achieve an out-of-focus position.

Once the desired reticle focus is achieved, lock the eyepiece in place by turning the lock-ring into firm contact with the eyepiece while holding the eyepiece in position. Tighten the lock-ring against the eyepiece so that the eyepiece, lock ring and power zoom ring move as a single unit. If the reticle tends to fade in and out of focus, or you are experiencing eye strain with extended shooting sessions, that is an indicator that the reticle is not properly focused for your eye. Once you have achieved the best focus

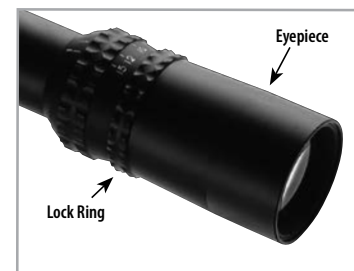

Figure 1: Reticle Focus

possible using the method above, it is recommended that you fine-tune the focus one to two turns in either direction, on a target at 100 to 200 yards. Use a target of medium value such as light tan or gray rather than white for best results. A properly focused reticle will remain sharp for extended periods.

## Parallax Adjustment (2.5-10x42 only)

Nightforce 2.5-10 x 42 riflescopes have a parallax adjustment on the left side of the riflescope. See Figure 2. Parallax is caused by the target and the reticle being on different focal planes, which causes an apparent movement of the reticle in relation to the target. A nod of the head up and down—without moving the riflescope—will quickly determine if parallax is present. If parallax has been eliminated, the reticle will remain stationary in relation to the target regardless of eye placement.



Figure 2

**Note:** The greater the distance, the greater parallax-induced error becomes. Especially at longer distances, significant sighting error can result if parallax is not removed.

For the latest updates and information regarding our products, visit [www.NightforceOptics.com](http://www.NightforceOptics.com).

## Elevation and Windage Values

When making elevation and windage adjustments, you need to know how much the impact will move with each click. Scope adjustments are an angular system of measurement and do not move in a linear value. (e.g., 1 MOA is 1.047" at 100 yards, 2.094" at 200 yards, 3.141" at 300 yards, etc.) Depending on the model, your riflescope is going to have click values as follows (see Figure 3):

- NXS™ Compact riflescopes with MOA adjustments are calibrated in 1/4 (0.25) MOA increments. They provide true MOA measurements, where a MOA is 1.047" at 100 yards.
- NXS™ Compact riflescopes with Mil-Radian adjustments are calibrated in 1/10th mil clicks, and based on the TRUE mil of 3.43775 MOA.

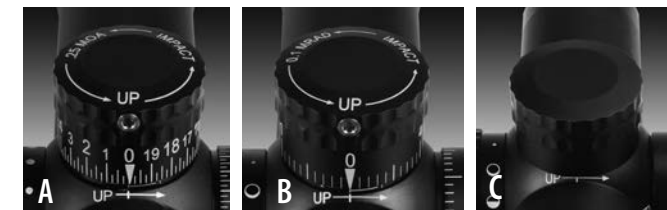

Figure 3

- A) MOA adjustments
- B) Mil-Radian adjustments
- C) Capped adjustments

## Reticle Illumination (Analog)

Reticle illumination can be used to make the reticle more visible in low light situations or against darker targets. The intensity of the illumination is easily adjustable in the field. Nightforce 1-4x and 2.5-10 x 32 NXS™ Compact riflescopes combine the reticle on/off switch and battery compartment in a single control on the left side of the riflescope. See Figure 4. The graphic icons on the adjustment indicate greater or lesser intensity positions, settings for night vision devices, and the off position. The adjustment can be turned in any direction.

To turn the illumination on, simply turn the adjustment to the desired intensity setting. There are two extremely low settings designed for use with night vision equipment, indicated by the 1/4 and 1/2 moon icons. The other icons indicate normal intensity settings, from very low (smaller circles) to extremely bright (larger circles).



Figure 4: Analog illumination control  
1-4x, 2.5-10 x 32 models

## Digillum™ Reticle Illumination

Nightforce 2.5-10 x 42 riflescopes feature Digillum™ digital illumination, including both red and green options as well as night vision compatibility. See Figure 5.

### Turning the illumination on and off

To turn on your Digillum™ illuminated reticle, simply press and release the illumination control located on the center of the side parallax adjustment. The reticle will illuminate to the last intensity and color setting. To turn your Digillum™ illuminated reticle off, press and hold the illumination control for 1-3 seconds.

### Adjusting illumination intensity (brightness)

Once turned on, by repeatedly pressing and releasing the illumination control you will change the intensity of the reticle. There are multiple intensity levels in the standard illumination mode. When the illumination reaches its minimum or maximum intensity, the reticle will flash three times. After reaching the minimum or maximum intensity, continuously pressing and releasing the illumination control will either increase or decrease the intensity away from the respective setting.

### Selecting the reticle color

The Digillum™ illuminated reticle allows the user to choose between red or green reticle illumination. By pressing the illumination control for about five seconds, the color will change from red to green or green to red.

### Entering night vision compatibility mode

Night vision compatibility mode is available in green illumination only. The night vision compatible settings are not visible to the naked eye and can only be seen when viewed through a night vision device mounted to the rear of the optic. There are multiple night vision compatible illumination intensity settings to choose from. Press and hold the illumination control for eight seconds, then release to activate the night vision compatible illumination settings.

### Exiting night vision compatibility mode

By pressing the illumination control for eight seconds then releasing, the illumination will return to the last used intensity level in red.



Figure 5: Digillum™ illumination control  
2.5-10 x 42 models

For the latest updates and information regarding our products, visit [www.NightforceOptics.com](http://www.NightforceOptics.com).

## Battery Replacement

The battery is held underneath the adjustment cover, which is removed by turning the knurled portion of the adjustment cover counterclockwise until the cover comes off. See Figure 6.

In riflescopes with analog reticle illumination, depending upon on the conditions, your battery can produce up to 700 hours of continuous use at its lowest intensity. With Digillum™ reticle illumination, your battery can produce 29 hours of continuous use at maximum illumination and up to 350 hours at its lowest intensity. Replace depleted batteries with an Energizer® CR2032 or equivalent. Install the battery with the positive (+) side up. Don't forget to turn off the illumination when not in use to prevent depletion of the battery. Refer to the analog or Digillum™ illumination instructions, depending upon which model you own.



Figure 6:  
Battery replacement



#### WARNING!

*Make sure that your rifle is unloaded prior to installing any Nightforce riflescope or accessory. Recheck the chamber if you stop the procedure and resume later.*

## Installing the Riflescope

**FAILURE TO PROPERLY INSTALL THE RIFLESCOPE MAY CAUSE EQUIPMENT AND/OR PERSONAL DAMAGE WHICH CAN RESULT IN EQUIPMENT FAILURE OR DEATH RESPECTIVELY.**

**Note:** Please take time to record your serial number on the inside front cover of this booklet. It can then be easily referenced for your online Warranty Registration. Once the scope has been installed, you may not be able to read the serial number, as your rings/mounts may cover it.

### Nightforce Torque Specifications

- Base and Direct Mount™ attachment screws - 25 inch pounds
- Ring top screws - 25 inch pounds
- Ring crossbolt nut - 68 inch pounds
- Ring crossbolt nut for six-screw 34mm rings - 100 inch pounds
- Unimount™, Extended Unimount™ and MagMount™ crossbolt nut - 68 inch pounds

### Ring and Base Selection

Your riflescope and rifle are only as good as the link between them. The mounting of your riflescope is as important as the bedding of the rifle's action to the stock. To ensure the highest level of performance, the following steps in the mounting procedure must be followed as described.

We recommend Nightforce bases, rings and one-piece mounts for a solid and precise installation. Please use the following guidelines to select the proper mounting solutions for your rifle.

- A high quality ring and base combination using a 1913 Mil. Std. type rail is recommended for field use and/or high-recoil applications. Nightforce rings, bases, Unimount™, MagMount™ and Direct Mount™ are ideal for virtually all applications.
- Under no circumstances do we recommend the use of turn-in style rotary/dovetail-type ring and base designs, especially those equipped with windage adjustment.
- If we do not offer a ring/base combination that is compatible with your firearm, please consider using Talley Mfg. or Warne products.

### Mount Installation

**Note:** Do NOT lap the Nightforce Unimount™, Extended Unimount™, Direct Mount™, MagMount™ or Ultralite™ rings. Lapping is not necessary with these Nightforce accessories. Lapping these products will

void the Nightforce accessory warranty and may lead to slipping and/or crushing of the Nightforce riflescope main tube. Other manufacturer's ring/base combinations may or may not require lapping.

### Attaching the Base to the Action

Once you have determined that the base-to-action mating is acceptable, install the base to the action, torquing the mounting screws to the manufacturer's specifications.

### Attaching Rings to Base

Clean/degrease the inside of the rings and then clean the outside of the scope tube before installing in the rings.

Install the rings on the base per the manufacturer's specifications using the proper torque on the locking mechanism. Avoid positioning the rings where they will make contact with the adjustment assembly, the objective bell section, or the power zoom ring on the riflescope body. Apply forward pressure to the ring while tightening it in place to keep the cross bolt on the ring in firm contact with the forward surface of the cross slot in the base.

With Nightforce rings and one-piece bases you should not lap the rings. With other brands lapping may be required. If the scope lays into the rings stress-free, there is no need to lap the rings. If required, we recommend lapping be done by a qualified technician or gunsmith. Do not overlap the rings. Damage to the scope from improper lapping/installation is not covered by the warranty.



#### WARNING!

*With hard-recoiling rifles, serious injury or even death can result from eyepiece impact with the shooter during the recoil process when discharging the firearm. Be certain that your installation provides sufficient eye relief for the recoil generated by your rifle before shooting the firearm. NOTE: Give special attention to this warning when shooting uphill and/or from a prone position. These shooting conditions can dramatically reduce eye relief. PLEASE maintain maximum eye relief when shooting heavy recoiling and/or magnum firearms.*

### Mounting the Riflescope

1. For initial fitting of the riflescope to the rifle, set the Nightforce riflescope to the highest magnification. Place the riflescope in the lower portion of the rings as far forward as possible. Install both ring tops. Tighten ring top screws with just enough tension to hold the riflescope where positioned, while still allowing smooth movement fore and aft and rotationally.
2. Hold the rifle in your normal shooting position with the riflescope positioned fully forward in the rings, preferably while adjusted to maximum magnification. Place your head as far forward on the stock as you might position it in field use. Slowly move the riflescope back just to the point

where the full field of view is obtained. It is recommended to mount the riflescope at this position with as much eye relief as possible (3.5"–4") or slightly forward to ensure maximum eye relief. See Figure 7.

**Note: Please see warning on page 9 regarding sufficient eye relief. Eye relief will change with the thickness of the clothing you wear and may need to be readjusted.**

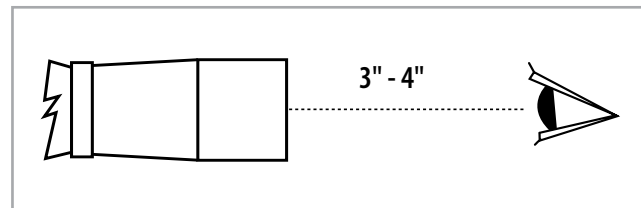

Figure 7: Eye relief

## Leveling the Reticle

For precision shooting, the reticle and the rifle need to be squared, or plumb, to each other. Any out-of-square condition can cause sighting errors that will be magnified even more at longer distances.

The reticle in all Nightforce scopes is confirmed plumb with the flat surface on the bottom of the adjustment saddle. See Figure 8. You can use pin gauges, a sliding sine bar or flat shims to align the flat surface with the top of the scope rail. To level the reticle using a plumb line, follow these steps:

1. Level the rifle on a steady rest such as sandbags or a stable shooting rest. This can be accomplished with a bubble level attached to the riflescope base, or on a flat section of the action.
2. Use a plumb line or some other known plumb vertical line at a distance from the rifle where you can see it clearly through the riflescope. A distance of 100 yards is recommended, but good results can often be obtained as close as 50 yards.
3. Center the reticle on the plumb line and rotate the riflescope in the rings until the vertical line of the reticle is parallel with the plumb line. Recheck the rifle level and adjust the reticle position as needed. When both the rifle and the reticle are plumb, tighten all ring top screws evenly until the riflescope is secure in the rings. Recheck the rifle and reticle one more time for plumb, adjust as needed, then torque the screws to the recommended torque settings. Your Nightforce riflescope is now properly mounted.

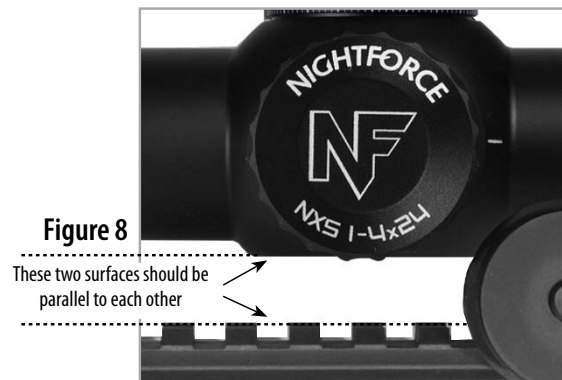

Figure 8

These two surfaces should be parallel to each other

## Establishing a Sight-in Zero

A quick way to get your first shot on target with a new installation is to first bore sight the riflescope. A simple yet reliable method is by looking through the bore at a round, high contrast target, approximately 5"–6" in diameter, that can be seen clearly with the naked eye at either 25, 50 or 100 yards/meters, yet is small enough to "float" in the center of the rifle bore when viewed through the opened action. This can save you time and ammunition.

1. Ensure that the rifle is unloaded and the chamber is empty. Remove the bolt and place the rifle on a steady rest.
2. Looking through the bore from the action end, center the round target downrange so that it is floating in the center of the bore, then adjust the elevation and windage adjustments until the reticle is centered on the target while the target is still centered in the bore. See Figure 9.
3. If you feel confident in the bore sighting, proceed to live firing at 25, 50 or 100 yards/meters. To aid in the sight-in process, be sure your sight-in target is large in size, and offers a contrasting color (i.e., white). After confirming

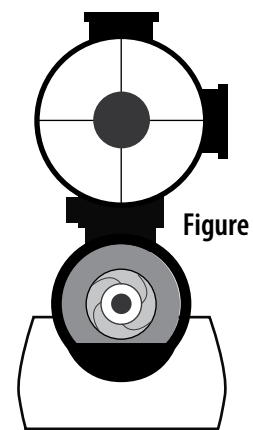

Figure 9

point of impact, proceed to step four. Note: if you have sighted in at 25 yards/meters, you will need to move the adjustments four times more than you would with a 100 yard/meter sight-in. If you sighted in at 50 yards/meters, you will need to move the adjustments two times more than you would with a 100 yard/meter sight-in. If the first shot isn't on target, recheck your bore sighting and/or move to a 25 yard/meter sight-in distance.

4. Without changing the adjustments, move the rifle to center the reticle on the target. Carefully turn the windage and elevation adjustments without moving the rifle, until the reticle is aligned on the center of the bullet hole from that first shot on the target.
5. Fire at least a three-shot group at the desired close-range zero distance, then fine-tune your zero as needed.

## PTL™ (Power Throw Lever) See "Nomenclature," page 3

The PTL™ is designed to allow rapid magnification changes, just by feel. First, ensure that your firearm is unloaded. Your riflescope arrives with a flush black insert screwed into the power zoom ring. To remove it, turn it counterclockwise with the supplied 5/64" Allen wrench. You can then install the PTL™ (included with your riflescope) by screwing it clockwise into the threaded hole. Tighten it securely with the Allen wrench, but take care not to overtighten the PTL™ to avoid stripping the threads or hex hole. Keep the insert in a secure place should you wish to remove the PTL™ in the future and reinstall it.

## Zeroing Adjustments

**NOTE:** The procedures are different for NXS™ Compact riflescopes equipped with non-ZeroStop™ Hi-Speed™ Adjustments (A) and optional ZeroStop™ Hi-Speed™ Adjustments (B). Non-ZeroStop™ adjustments are offered only in a capped configuration. See Figure 10.

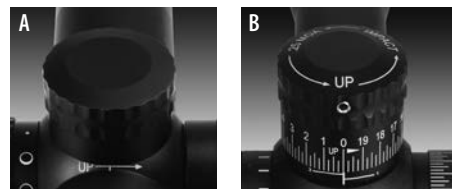

Figure 10

Non-ZeroStop™ capped

ZeroStop™  
NIGHTFORCE

### Non-ZeroStop Capped Adjustments (2013 models and newer)

Zero your rifle scope with your chosen load (see instruction manual). To then reset the number scale to 0, remove the dust cap by rotating it counter-clockwise.

- 1) While holding the adjustment dial, loosen the two set screws on top of the dial using the supplied 5/64" Allen wrench. The dial should now rotate freely, and you should not feel any clicks. See Figure 11, step 1.
- 2) Rotate the dial clockwise until it stops. See Figure 11, step 2.

3) Turn the dial counter-clockwise until the "0" on the dial is aligned with the fixed zero reference mark below. See Figure 11, step 3.

4) While holding the dial, tighten both set screws to 4 inch-pounds. If you don't have a torque driver, use the Allen wrench, holding the short end of the wrench while turning to prevent over-tightening. See Figure 11, step 4.

Replace the dust cap and turn it clockwise until it is secure.

Figure 11

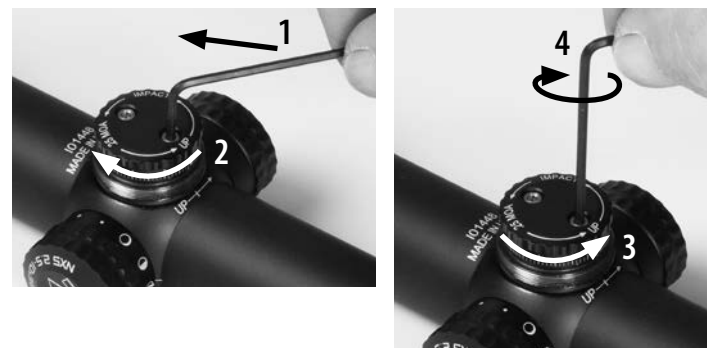

## ZeroStop™ Elevation Adjustments (optional)

**CAUTION:** At some point in the zeroing process, you may reach the travel limit of the elevation or windage adjustment mechanisms, which is not the same as the stops from the ZeroStop®. Do NOT force the adjustment or damage may occur.

**CAUTION:** The rifle scope is NOT waterproof with the adjustment dials removed. Do NOT allow water or foreign material to accumulate on the exposed turret components. Do NOT remove the grease or O-rings found on the inside of the turret assembly and under the adjustment set screw.

ZeroStop® is an optional feature for Nightforce riflescopes. Please confirm if your model is equipped with this option before proceeding with these instructions. ZeroStop® prevents you from inadvertently losing your zero, by providing a positive mechanical stopping point once it is properly set. When the desired zero has been established, regardless of the position of the adjustment, turning the elevation knob down to the ZeroStop® setting will guarantee that you are back to your original zero.

You can set the stop at any zero/range you prefer as described below. Once the ZeroStop® is set, you may quickly return to the zero point by moving the elevation adjustment down (clockwise) until it stops.

1. Prior to installing your Nightforce rifle scope or making any adjustments to ZeroStop®, MAKE SURE FIREARM IS UNLOADED!
2. REPEAT STEP # 1!
3. After you have properly installed your rifle scope, you can then proceed to zero/sight-in your rifle.

For the latest updates and information regarding our products, visit [www.NightforceOptics.com](http://www.NightforceOptics.com).

4. After you have determined the ammunition that performs best for your intended use and established the zero/sight-in, please use the following instructions to set your ZeroStop®.

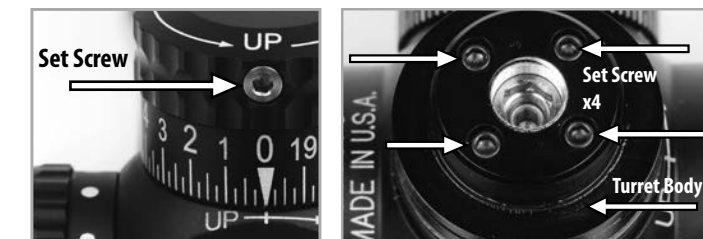

Figure 12

Figure 13

To set your ZeroStop® (2.5-10x models only):

- A. For detailed video instructions, and to see more advanced uses of your Nightforce ZeroStop®, please visit [www.NightforceOptics.com/videos](http://www.NightforceOptics.com/videos).
- B. Remove elevation adjustment cap by loosening the set screw 1½ to 2 turns, using the larger (5/64") Allen wrench provided in the box. Take care not to remove the screw entirely or lose it. See Figure 12.
- C. Lift the cap upward with a slight twisting motion to remove it from the adjustment. You should feel slight resistance. Set the cap aside on a clean surface. Note: You should not feel any "clicks" during twisting motion. If you do, you have likely changed your initial zero. Loosen the set screw an additional ½ turn so the cap will rotate freely.
- D. You have now exposed the ZeroStop® clutch assembly. Take care to maintain the cleanliness of the inside of the cap and the clutch area. Do not remove any of the lubricating grease.

- E. While holding the clutch assembly securely in place, loosen each of the four Allen head screws on the **ZeroStop®** clutch assembly 1½ to 2 turns counter-clockwise using the smaller (1/16") Allen wrench provided in the box. **DO NOT** remove the screws from the clutch assembly. See Figure 13.
- F. To set the **ZeroStop®** clutch assembly, rotate the upper clutch face downward/clockwise until it stops against the lower clutch face. See Figure 14. Note: You should not feel any "clicks" or resistance while making this adjustment.
- G. While holding the clutch mechanism in position, tighten the four Allen head screws on the clutch assembly evenly in an "X" pattern, using the smaller (1/16") Allen wrench provided in the box. **Do not over-tighten the screws as this can damage the clutch assembly.** Tighten one screw until you feel slight resistance, then move to the next screw in the "X" pattern. Continue to do the same for all four screws. Once all screws have been tightened to that point, repeat the same pattern, tightening all to 4 inch-pounds. If you do not have the appropriate torque driver, then use the 1/16" Allen wrench, holding the short end of the Allen wrench with your thumb and forefinger. This will provide sufficient torque. See Figure 15.
- H. To reinstall the adjustment cap, center it over the adjustment body, and press down lightly while turning the cap clockwise until it moves into position. Keep downward pressure on the cap as it may tend to move up due to the compressed air resistance created by the O-ring seal. Align the "0" index mark on the engraved scale of the cap with the center line on the scope body and tighten the set screw to 4 inch-pounds (see Figure

12). If you do not have the appropriate torque driver, then use the 5/64" Allen wrench, holding the short end of the Allen wrench with your thumb and forefinger. This will provide sufficient torque (Do not remove the set screw.)



**Figure 14**



**Figure 15**

#### To set your ZeroStop® (1-4x models only):

First, zero your rifle scope as normal. The ZeroStop™ allows one rotation of elevation adjustment. If you need more than one rotation to zero in, loosen the adjustment's set screw, lift the cap, rotate the cap so its "0" index mark aligns with the center line on the scope body and retighten the set screw.

Once you have zeroed your rifle scope, to set ZeroStop™, loosen the set screw again, lift the cap, rotate the cap so its "0" index mark aligns with the center line on the scope body and retighten the set screw. Follow these same instructions for setting your windage limiter adjustment.

## Caring for Your Riflescope

With proper care your Nightforce riflescope will give you many years of dependable service. Be sure to use your lens covers whenever you are not using your riflescope.

### Cleaning the Riflescope Exterior

Clean the riflescope body with a clean cloth lightly moistened with clean water or alcohol. Do not use strong solvents. While cleaning your rifle, be sure to protect your riflescope's lenses by installing the covers that came with the riflescope (or equivalent covers). Ammonia-based bore solvents can destroy the coating on the glass. Avoid spilling gun cleaning solvents anywhere on the riflescope.

In the event of submersion in mud, sand, dirty or salt water, flush the outside of the riflescope with clean water to remove encrusted material and salt. If your riflescope came with screw-on adjustment covers, install them before flushing with water. Wipe the outside metal surfaces dry with a soft cloth then proceed to the step below.

### Cleaning Lenses

We recommend using a Nightforce cleaning kit A130 to care for the lenses on your riflescope. The kit contains an ultra-soft brush, microfiber cloth and cleaning solution.

With the lens facing down to allow the debris to fall away from the surface, remove loose dirt and dust with compressed air and/or a lens brush. Do NOT

use high-pressure compressed air from cans (such as found in office supply stores). They can, and have, been known to destroy lens coatings. If there is grit stuck to the lens that won't come off with the compressed air or a brush, flushing the surface with alcohol or distilled water will prevent that grit from being rubbed into the glass by the cleaning swabs.

Using a soft, clean, lint-free cotton swab or lens cleaning cloth, and lens cleaning fluid applied to the swab, clean the lens starting in the center, working to the outside in a circular motion. Make only one pass to the edge where the glass meets the metal. Once you reach the edge of the lens, do not re-use that swab as it will often contain abrasive grit that will scratch the surface. Start over in the center with a new swab and repeat the process until the glass is clean. Use a very small amount of cleaning solution for the last pass to prevent streaks.

### Long Term Storage

If the riflescope will not be used for an extended period, remove the battery and store it separately. Keep the riflescope in a cool, dry, dust-free location.

**For a list of frequently asked questions, video instruction, information on service and on Nightforce accessories, visit [www.NightforceOptics.com](http://www.NightforceOptics.com).**

### Online warranty registration:

**Visit [www.NightforceOptics.com/WarrantyRegistration](http://www.NightforceOptics.com/WarrantyRegistration) to activate your warranty, register for Nightforce gear and to receive updates and future product support.**





We are proud to back up Nightforce ATACR™, B.E.A.S.T.™, Benchrest, Competition™ and NXS™ riflescopes with a transferable Limited Lifetime Warranty which covers mechanical defects in materials and workmanship in the optical and mechanical components of the riflescope. In the event of a defect in materials or workmanship that is covered by this warranty, we will either repair the riflescope or replace it at no charge, with a comparable product at our discretion.

Exclusions to this warranty include intentional or accidental damage, abuse, misuse, unauthorized modifications or repairs, and improper mounting. This warranty does not cover any consequential or incidental damages resulting from the inability to use the riflescope. Any serial number obliteration or alteration on the product will void the warranty.

To ensure warranty coverage, please register online or fill out completely and mail in the provided warranty card found in the back of the owner's manual, along with a copy of the sales receipt. The warranty begins on the date the product was purchased by the original owner. The optical and mechanical components are covered without time limitations. The electronic components are covered for a period of three years.

This warranty gives you specific legal rights, and you may also have other rights which vary from state to state. Some states do not allow the exclusion or limitation of incidental or consequential damages, so the above limitations or exclusions may

not apply to you. Some states do not allow limitations on how long an implied warranty lasts, so the above limitations may not apply to you.

**Before sending a riflescope in for service, please call Nightforce Optics, Inc. at the number below, to determine if the problem can be resolved without sending us the product. All returns must be accompanied by a Return Merchandise Authorization (RMA) number. Failure to do so can result in lost merchandise and/or severely delayed service time.**

- Remove any mounting rings or accessories other than dust covers and the original sunshade.
- Record and keep on hand the serial number.
- Include with the riflescope a detailed description of the defect(s), the RMA number, your name, phone number and the address you wish the riflescope returned to.
- Place the boxed or protectively wrapped riflescope in a well-padded outer box insured for replacement value and send it shipping prepaid, to the appropriate address below. **Write the RMA number on the outside of the package.**

**U.S.A. & Canada:**  
**Nightforce Optics, Inc.**  
**Attention: Service Dept.**  
**336 Hazen Lane**  
**Orofino, Idaho 83544**  
 tel 208.476.9814  
 fax 208.476.9817  
 www.NightforceOptics.com

**International:**  
**Nightforce Optics**  
**Attention: Service Dept.**  
**28 Orsmond Street**  
**Hindmarsh, SA 5007 Australia**  
 tel +61 (0)8 8440 0888  
 fax +61 (0)8 8346 0504  
 www.NightforceOptics.com

Be sure to register your warranty at  
[www.NightforceOptics.com/WarrantyRegistration](http://www.NightforceOptics.com/WarrantyRegistration)

## Nightforce Warranty Registration Card

Activate your warranty at [www.NightforceOptics.com/WarrantyRegistration](http://www.NightforceOptics.com/WarrantyRegistration) and be eligible for product support, updates and additional Nightforce gear. If you do not have Internet access, please tear out, fill in and return this product registration card within 30 days of purchase. Return to the address below along with a copy of your purchase receipt. We retain this card for warranty eligibility.

Name: \_\_\_\_\_

Address: \_\_\_\_\_

City: \_\_\_\_\_ State: \_\_\_\_\_ Zip: \_\_\_\_\_

Phone No.: \_\_\_\_\_ Email: \_\_\_\_\_

Model: \_\_\_\_\_ Serial No.: \_\_\_\_\_

Date of Purchase: \_\_\_\_\_ Purchased From: \_\_\_\_\_

Please take a moment to provide your comments on the following page.

To locate your serial number:

NXS™ Compact, NXS™ F1 and B.E.A.S.T.™ scopes: On the top of the tube body, in front of the elevation adjustment.

NXS™ 15x, 22x, 32x, 42x, ATACR™, Benchrest and Competition™ scopes: On the bottom of the tube body in front of the power change ring.

If you have already mounted the riflescope and cannot find the serial number, it is probably covered by the scope rings.

Attach a copy of your receipt and send to: **Nightforce Optics, Inc.**  
**336 Hazen Lane**  
**Orofino, Idaho 83544**

Register online at  
[www.NightforceOptics.com/WarrantyRegistration](http://www.NightforceOptics.com/WarrantyRegistration)

Please detach here

## Nightforce Owner's Comments

Your feedback and suggestions will help us maintain the high level of quality and customer service Nightforce owners have come to expect. We encourage your input.

What changes or modifications would you recommend be made to improve this product? \_\_\_\_\_

What new products would you like to see offered by us? \_\_\_\_\_

What hunting/shooting magazines do you normally read? \_\_\_\_\_

What hunting/shooting television programs do you like to watch? \_\_\_\_\_

Do you participate in Internet forums or blogs? Which ones? \_\_\_\_\_

How did you hear about Nightforce products? \_\_\_\_\_

Are you a member of a local rifle shooting club or range?  Yes  No Do you participate in any of the following competitive shooting events?  
If so, please check the appropriate box:  Long-range benchrest  Short-range benchrest  F-Class  Precision tactical  3-Gun  Tactical  
 Other (please explain) \_\_\_\_\_

Do you travel to participate in competitive shooting events?  Yes  No If so, how far do you typically travel? \_\_\_ Miles \_\_\_ Hours

Please detach here

## A reticle for every reason.

Nightforce offers the most extensive selection of proprietary reticles on the market. We make highly precise MOA- and MIL-based designs, fast and accurate reticles for big game hunting, and our unique Velocity™ reticles tailored to the ballistic profile of your rifle.

We can generally retrofit a newer reticle to an older Nightforce riflescope (assuming it is offered in the same model riflescope that you own).

The clarity, resolution, brilliance and ruggedness of a Nightforce riflescope is only part of the accuracy equation. A reticle created for ultimate performance in your chosen application is the other essential component.

We have a reticle for every reason. And every season.

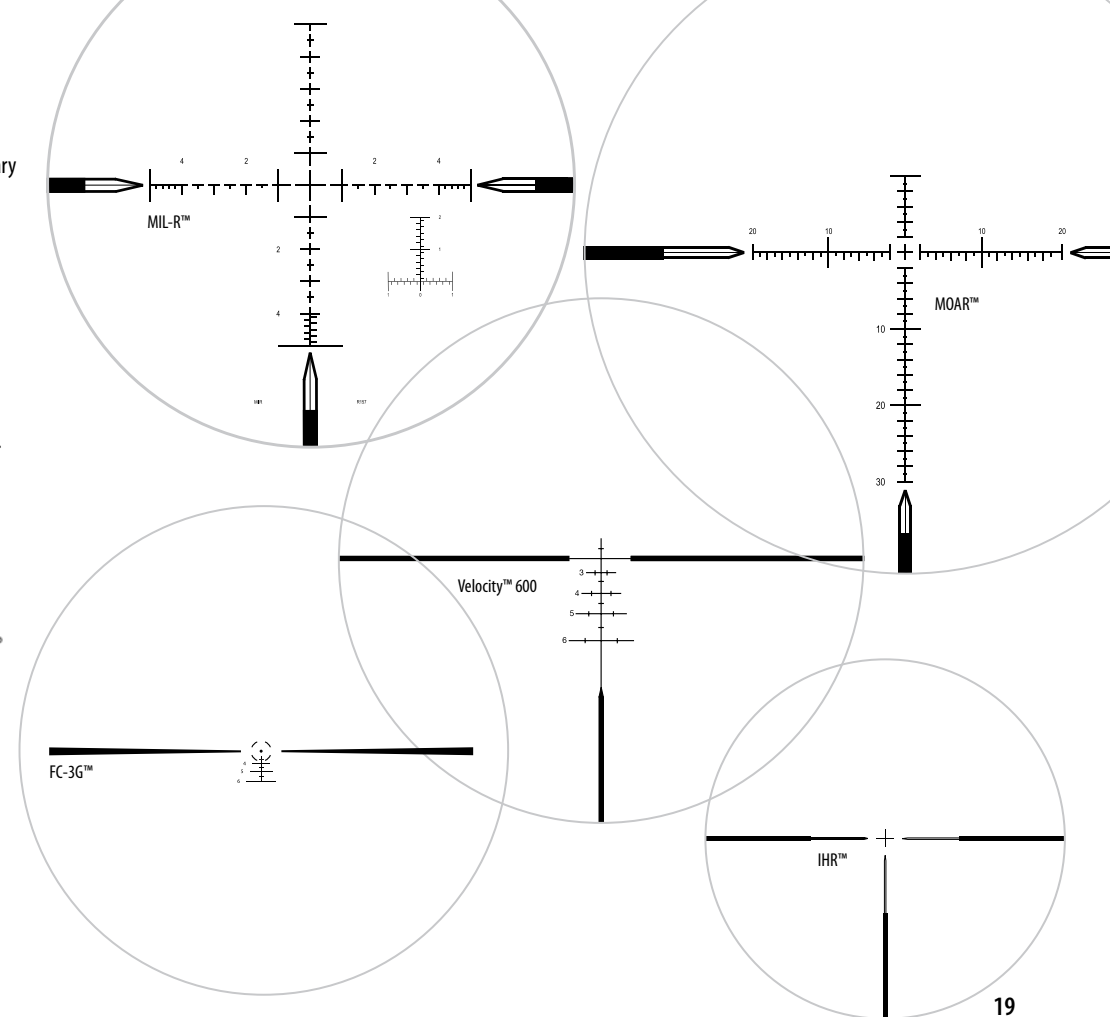



# NIGHTFORCE®



**Factory/Headquarters U.S.A.**

**Customer Service, Technical & Warranty:**

Nightforce Optics, Inc.  
336 Hazen Lane  
Orofino, ID 83544  
tel 208.476.9814 • fax 208.476.9817  
info@nightforceoptics.com

**U.S.A. Dealer Sales:**

Nightforce Optics, Inc.  
2749 Providence Church Road  
Lavonia, GA 30553  
tel 706.434.8950 • fax 706.449.0930  
dealersales@nightforceoptics.com

**Military, Government & Law Enforcement:**

Nightforce Optics, Inc.  
2749 Providence Church Road  
Lavonia, GA 30553  
tel 706.434.8953 • fax 706.449.0931  
militaryinfo@nightforceoptics.com

**European & Canadian Sales:**

Nightforce Optics, Inc.  
2749 Providence Church Road  
Lavonia, GA 30553  
tel 706.434.8952 • fax 706.449.0930  
intlsales@nightforceoptics.com

**Australia & South Pacific Sales:**

Nightforce Optics  
28 Orsmond Street  
Hindmarsh, SA 5007  
Australia  
tel +61 (0)8 8440 0888  
fax +61 (0)8 8346 0504

All trademarks, graphics and designs herein are the property of Nightforce Optics, Inc. Product specifications are subject to change without notice. Products may differ in appearance from those shown here; not responsible for typographical errors. Visit [www.NightforceOptics.com](http://www.NightforceOptics.com) for current information, tutorials, and video. Lightforce USA, dba Nightforce Optics, Inc.

©Nightforce Optics, Inc. 2013 5/13